

#### Dimension(mm)

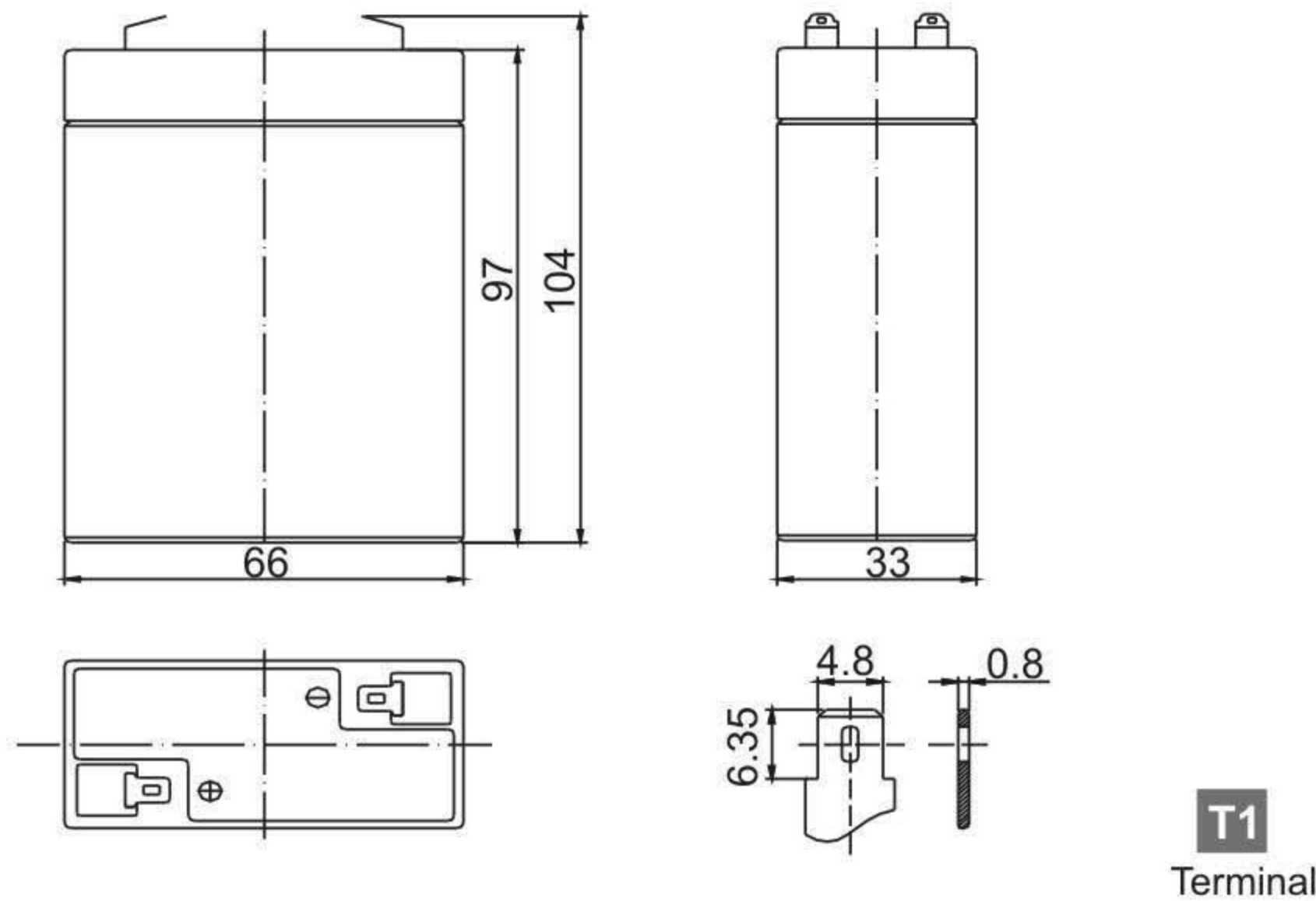

#### Specification

Nominal Voltage	6 V	
Capacity(20HR, 25°C)	2.8Ah	
Dimension	Length	66mm (2.60inch)
	Width	33mm (1.30inch)
	Height	97mm (3.82inch)
	Total Height	104mm (4.09inch)
Approx. Weight	0.60kg (1.32lbs)	

#### The Relationship for Open Circuit Voltage and Residual Capacity (25°C)

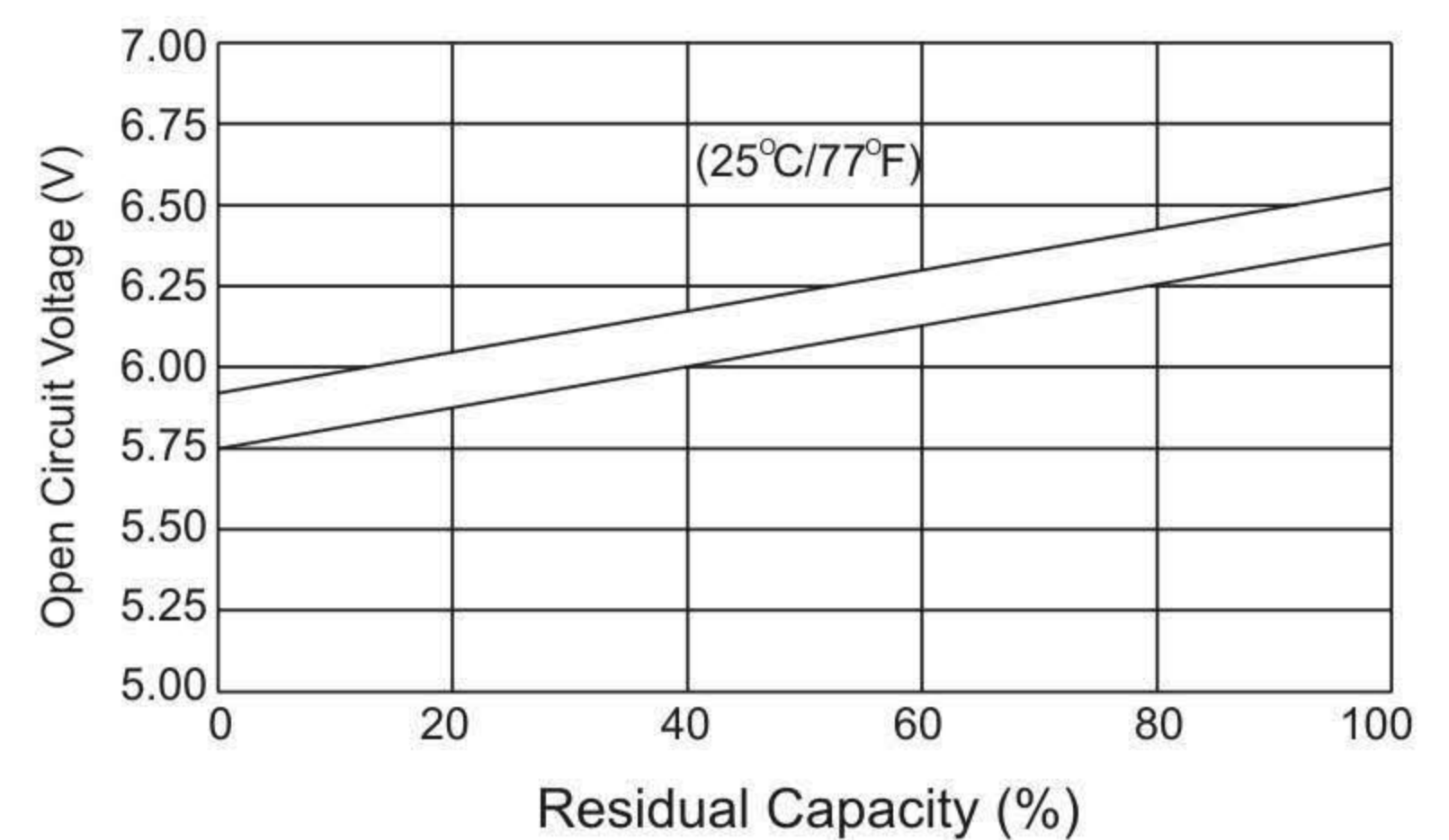

#### Characteristics

Capacity 20°C (68°F) To 1.70V/Cell	20 hour rate	2.8Ah
	10 hour rate	2.6Ah
	5 hour rate	2.25Ah
	1 hour rate	1.76Ah
	15 min rate	1.32Ah
Internal resistance(Fully charged, 25°C)	Approx. 25mΩ	
Capacity affected by temperature (20HR)	40°C	102%
	25°C	100%
	0°C	85%
	-15°C	65%
Self-discharge (25°C)	3 month	Remaining Capacity: 91%
	6 month	Remaining Capacity: 82%
	12 month	Remaining Capacity: 65%
Nominal operating temperature	25°C ± 3°C (77°F ± 5°F)	
Operating temperature range	-15°C ~ 50°C (5°F ~ 122°F)	
Float charging voltage(25°C)	6.80 to 6.90V	
Cyclic charging voltage(25°C)	7.25 to 7.45V	
Maximum charging current	0.84A	
Terminal material	Copper	
Maximum discharge current	42A(5 Sec.)	

#### Charging Characteristics(25°C)

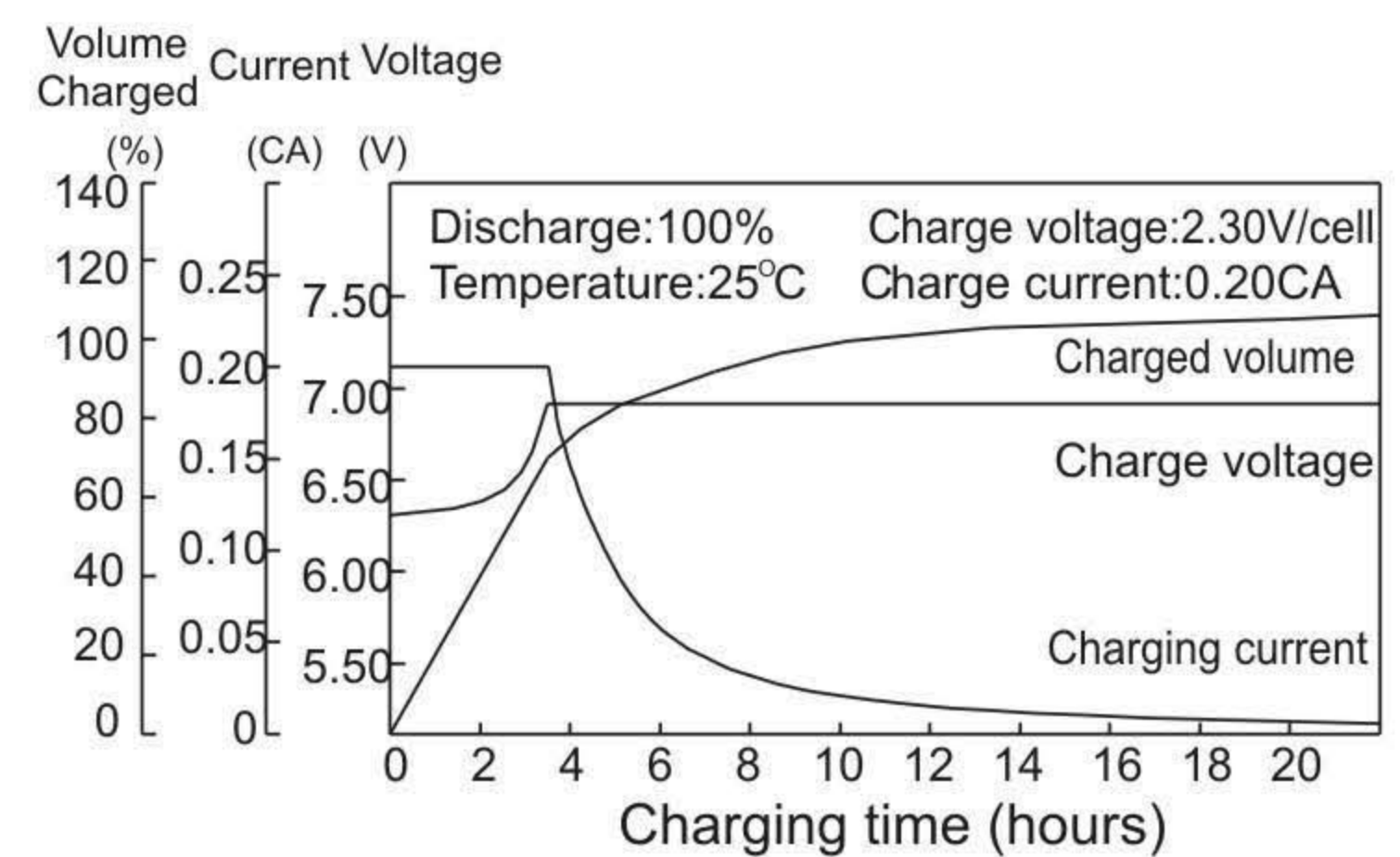

#### Cycle Life(25°C)

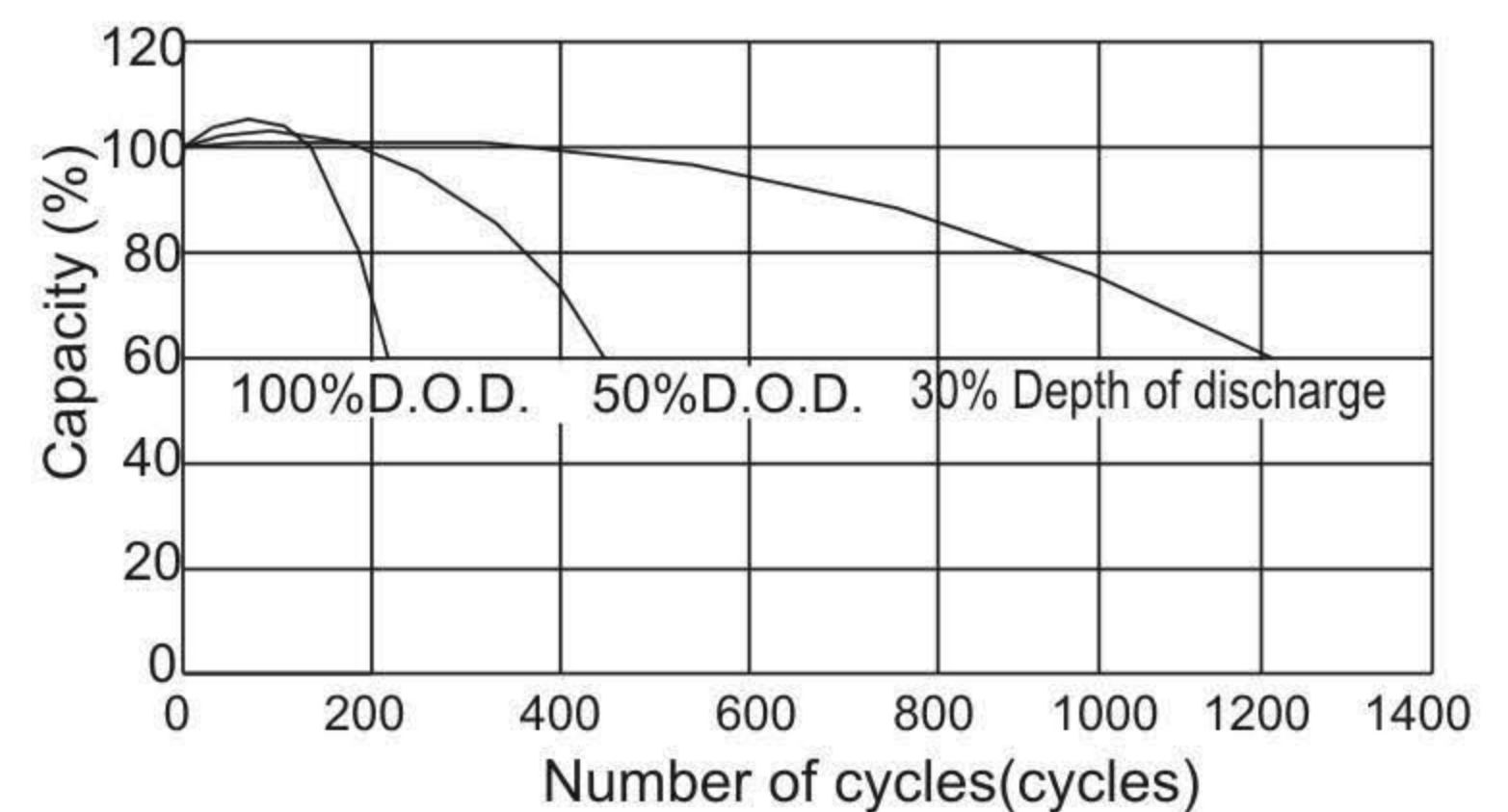

#### Constant Current Discharge Characteristics (A, 25°C)

F.V/TIME	5min	10min	15min	30min	60min	3h	5h	10h	20h
4.80V	11.5	7.02	5.50	3.10	1.83	0.71	0.46	0.26	0.14
5.10V	10.9	6.84	5.28	2.98	1.76	0.70	0.45	0.26	0.14
5.40V	10.2	6.43	5.02	2.83	1.67	0.69	0.44	0.25	0.14

#### Constant Power Discharge Characteristics (Watt, 25°C)

5min	10min	15min	30min	60min	3h	5h	10h	20h
64.2	40.6	31.4	17.8	10.6	4.22	2.73	1.52	0.85
61.0	38.6	30.1	17.1	10.2	4.16	2.69	1.51	0.85
57.3	36.3	28.6	16.2	9.7	4.07	2.63	1.51	0.84